

# **ASSAM POWER GENERATION CORPORATION LIMITED**

OFFICE OF THE CHIEF GENERAL MANAGER (HYDRO & CIVIL),

BIJULEE BHAWAN, GUWAHATI-781001



**E-Tender Notice No. APGCL/CGM (Hydro & Civil)/2024-25/NTPS precast boundary wall/07(26) dated:08/10/2024**

NAME OF THE WORK: Construction of precast boundary wall for length of 701 M in the eastern side of NTPS, APGCL Namrup, District- Dibrugarh

**October-2024**

Price: - ₹2100/-  
(Non-Refundable)

## **INDEX**

<b><u>Chapter</u></b>		<b><u>Page No</u></b>
Chapter-I	Tender Notice	..... 2
Chapter-II	Terminology	..... 4
Chapter-III	Instruction for bidders and special Conditions	..... 5
Chapter-IV	Safety Engineering and Safety Code	..... 14
Chapter-V	Contractor's Camp	..... 15
Chapter-VI	Declaration	..... 16
Chapter-VII	Declaration of litigation	..... 17
Chapter-VIII	Schedule of work	..... 18
Chapter-IX	Bidder's Credentials	..... 21
Chapter-X	Drawings	..... 22

## CHAPTER-I

### TENDER NOTICE



#### **ASSAM POWER GENERATION CORPORATION LIMITED**

Registered Office: Bijulee Bhawan, 3<sup>rd</sup> floor, Paltanbazar, Guwahati-781 001, Assam.

Email: [saurav.saikia@apgcl.org](mailto:saurav.saikia@apgcl.org),

Chief General Manager (Hydro & Civil)

**E-Tender Notice No. APGCL/CGM (Hydro & Civil)/2024-25/NTPS precast boundary wall/07(26)  
dated: 08/10/2024**

<b>Invitee</b>	The Chief General Manager (Hydro & Civil) 3 <sup>rd</sup> Floor Bijulee Bhawan, Paltanbazar, Guwahati, Assam, PIN-781001
<b>Name of work</b>	Construction of precast boundary wall for length of 701 M in the eastern side of NTPS, APGCL, Namrup, District:- Dibrugarh
<b>Duration of work</b>	<b>180 days (One hundred eighty days) from the date of signing of contract agreement.</b>
<b>Tendered value</b>	<b>Rs.1,04,50,843.00 (Rupees one crore four lakhs fifty thousand eight hundred forty three only) (inclusive of all taxes)</b>
<b>Eligibility of the bidder</b>	Experienced and financially sound Civil Engineering firms / contractors with <b>Average Annual turnover during last three Financial Years i.e. 2023-24, 2022-23 &amp; 2021-22 not be less Rs. 52,25,422.00 (50% of the tendered amount)</b> and having experience of successfully completing <b>similar works during the last 7 years</b> ending last day of month previous to the one in which applications are invited should be either of the following:- a. Three similar completed works costing not less than the amount equal to <b>Rs. 41,80,337.00 (40% of the tendered amount).</b> or b. Two similar completed works costing not less than the amount equal to <b>Rs. 52,25,422.00 (50% of the tendered amount).</b> or c. One similar completed work costing not less than the amount equal to <b>Rs. 83,60,674.00 (80% of the tendered amount).</b> (Supporting documents to be submitted).
<b>Tender fee (Non-refundable)</b>	<b>Rs. 2100/- (Rupees Two thousand one hundred only)</b> Tender processing fees must be deposited online as per instructions given vide as per OM. No. FEB. 269/2017/27 dated 21.08.2019. No exemption will be allowed in submission of tender fees of any bidder.
<b>Earnest Money Deposit (EMD)</b>	<b>Rs. 2,09,017.00 (for General)</b> <b>Rs.1,04,508.00 (for SC/ST/OBC) For Individual only</b> EMD amount should be deposited online as per Finance Department Govt. of Assam office memorandum (OM).No. FEB.269/2017/27 dated 21.08.2019. EMD through Bank Guarantee (BG) will also be accepted. No exemption will be allowed in submission of EMD of any bidder.
<b>Start date of Tender</b>	09/10/2024
<b>Last date and time of online bid submission</b>	11.00 a.m. on 24/10/2024
<b>Tender Opening</b>	Technical bid opening 03.00 p.m. on 24/10/2024

Bidder must download the Bidding Documents and submit the bid electronically on the portal <https://assamtenders.gov.in>

The Bidders will be required to submit the bids by using own Digital Signature Certificate with both Signing and Encryption Certificates (minimum Class-II Certificate). Prospective Bidders must procure DSC before participating in the tenders. The viewing & downloading of the bid document will be free of cost.

**Bid shall be submitted electronically/ online.**

**Price bid will be opened through reverse bidding.**  
**The bidder must submit the requisite tender fee and EMD through online as per Finance Department Govt of Assam office memorandum (OM) No. FEB. 269/2017/27 dated: 21.08.2019.**

The Bidders will be required to download the Bidding Documents from the web portals mentioned above. However, they will have to pay a non - refundable tender document fee as mentioned above online, the details of which are stipulated in the tender document. The acceptance of the bid shall be subjected to acceptance of both document fee and Bid security or EMD.

The Chief General Manager (Hydro & Civil), APGCL is not bound to accept the lowest rates and reserves the right to accept or reject any or all tenders without assigning any reason thereof.

Note: Any addendum/corrigendum/extension etc. in respect of this tender shall be issued on the portal <https://assamtenders.gov.in> and APGCL's website: [www.apgcl.org](http://www.apgcl.org).

Yours faithfully,

Handwritten signature in blue ink, appearing to be 'A.P.', with the date '08/10/2024' written below it.

Chief General Manager (Hydro & Civil)  
APGCL

Memo no: APGCL/CGM (H&C)/W/2019-20/785/78

Date: 08/10/2024

C.c. to: -

- 1) The OSD to The Hon'ble Chairman, APGCL, Bijulee Bhawan, Paltanbazar, Guwahati-781 001, for favour of kind information to The Hon'ble Chairman, APGCL.
- 2) The OSD to The Managing Director, APGCL, Bijulee Bhawan, Paltanbazar, Guwahati-781 001, for favour of kind information to The Managing Director, APGCL.
- 3) The Chief General Manager (Gen), APGCL, Bijulee Bhawan, Paltanbazar, Guwahati-781 001, for information.
- 4) The Chief General Manager (F & A), APGCL, Bijulee Bhawan, Paltanbazar, Guwahati-781 001, for information.
- 5) The General Manager, NTPS, APGCL, Namrup for information and necessary action and wide circulation.
- 6) The P.R.O., APDCL, Bijulee Bhawan, Paltanbazar, Guwahati-781 001, for information with a request to publish the notice in one issue of Local Dailies in Regional and English Language on or before 09/10/2024.
- 7) Relevant File.

## CHAPTER-II

### **1 TERMINOLOGY**

- 1.01** APGCL wherever used in this document shall mean Assam Power Generation Corporation Limited incorporated vide The Companies Act 1956 in exercise of Powers conferred under the Act including subsequent amendments, if any. APGCL is a successor company of ASEB.
- 1.02** CGM (Hydro & Civil) or owner or purchaser or project authority wherever used in this document shall mean the officer holding the post of the Chief General Manager (Hydro & Civil) APGCL, Guwahati (Assam), who or his authorized representative will exercise authority on behalf of the Department in respect of the Tender and the works specified herein.
- 1.03** Engineer-in-Charge/or engineer shall mean the Officer holding the charge of the Departmental post of General Manager/ Assistant General Manager (Civil) pertaining to supervision of works specified in this document.
- 1.04** The term 'Contractor' wherever used in this document shall mean the individual/firm or company who shall have entered into a contract agreement with the owner or the project authority, undertaking on his behalf to carry out the works in full or in part as may be specified in contract documents, and shall include in the case of an individual/ his heirs, administrators and permitted assignees, in case of a firm, the partners of the said firm, their respective heirs, executors, administrators and permitted assignees, and in case of a Company its successors and permitted assignees.
- 1.05** Contract documents shall mean and comprise the following documents and shall be the basis of agreement between the owner and the contractor for carrying out the works in accordance with the terms and conditions, specifications, drawings and directions contained in the said documents.
- a) Bid documents duly filled in respect of rates, process & signed, the tender forms properly filled in, signed and dated by the contractor & duly submitted.
  - b) Contractor's original bid proposal and subsequent correspondences relating to clarifications and negotiations, if any, prior to award of the contract.
  - c) Equipment, specifications and drawings, so far as applicable
  - d) Approved agreement forms duly signed, dated and sealed by the contractor and the owner as specified in the said forms
- 1.06** 'Equipment' and 'Plants' shall mean and include all sorts of machineries and accessories, apparatus, instruments, components manufactured articles and parts etc. to be supplied or provided by the contractor under the terms of the contract, unless otherwise specified
- 1.07** The 'Works' shall unless be repugnant to such description shall be construed and taken to mean the works contracted, or by virtue of the contract agreement, to be executed whether temporary or permanent and whether original, altered, substituted or additional.
- 1.08** The expression 'Specifications' wherever used in this document shall mean all the pertinent terms and stipulations furnished herein in respect of the work or part thereof and/or indicated in the drawings appended hereto and to be issued for construction and shall have reference also to other relevant terms and stipulations not furnished herein, but as far as applicable.

## **CHAPTER-III**

### **INSTRUCTION FOR BIDDERS AND SPECIAL CONDITIONS**

**E-Tender Notice No. APGCL/CGM (Hydro & Civil)/2024-25/NTPS precast boundary wall/07(26)  
dated: 08/10/2024**

**BID INVITATION FOR:**

Construction of precast boundary wall for length of 701 M in the eastern side of NTPS, APGCL, Namrup, District- Dibrugarh

**EARNEST MONEY DEPOSIT: Rs. 2,09,017.00 (for General)  
Rs.1,04,508.00 (for SC/ST/OBC) For Individual only**

**EMD amount should be deposited online as per Finance Department Govt. of Assam office memorandum (OM).No. FEB.269/2017/27 dated 21.08.2019. EMD through Bank Guarantee(BG) will also be accepted. No exemption will be allowed in EMD to any other bidder possessing any other certificate other than that specifically mentioned herein.**

**1. DUE DATE AND CLOSING TIME**

The bid will be received up to 11.00 A.M. of 24/10/2024. The opening time of the bids will be at 3.00 p.m. on the same day and the venue will be the office of the Chief General Manager (H&C), APGCL.

**2. TIME OF COMPLETION OF WORK**

The stipulated time of completion of the work is 180 (One hundred eighty) days from the date of signing of the contract agreement. No time extension shall be granted to the contractor irrespective of size and volume of the awarded work.

**3. BID-GUARANTEE OR EARNEST MONEY DEPOSIT: (E.M.)**

- i) Every bid or tender shall be accompanied by a deposit of Earnest Money (E.M.) for an amount indicated or as specified in the Tender Notice. EMD amount should be deposited online as per Finance Department Govt. of Assam office memorandum (OM).No. FEB.269/2017/27 dated 21.08.2019 (copy enclosed for ready reference). EMD through Bank Guarantee (BG) will also be accepted. If EMD is submitted through BG, bidder will be required to upload the scan copy of the BG during online Bid submission and the original Hard Copy of the BG should reach APGCL HQ on or before bid opening.

Address to which the Original BG is to be submitted on or before Bid Opening:  
The Chief General Manager (H &C)),  
Assam Power Generation Corporation Ltd.,  
3rd Floor, Bijulee Bhawan, Paltan Bazar, Guwahati-1.

The BG shall be duly pledged in favour of the Chief General Manager (F&A), APGCL and shall remain in force for 01 (one) year period from the Start Date of online Bid submission.

No interest shall be payable on such deposits.

Note: The bidder is requested to advise the Bank Guarantee issuing bank to comply with the following and ensure to submit, the receipt of the copy of SFMS message as sent by the issuing bank branch, along with the original bank Guarantee in APGCL's tender issuing office:

The Bank Guarantee issued by the Bank must be routed through SFMS platform as per following details:

- MT/IFN760/MT/IFN760 COV for issuing of Bank Guarantee.
- MT/IFN 760/MT/IFN 767 COV for amendment of Bank Guarantee.

The above message/intimation shall be sent through SFMS by the BG issuing bank branch to Axis Bank, Paltanbazar Branch, A/C no. 375010200001380, IFS code-UTIB0000375, Branch Address- AXIS Bank Ltd, Commercial Building, A.T. Road, Guwahati-781001, India.

ii) The Earnest Money as mentioned above will be returned to the respective bidders as per Finance Department Govt. of Assam office memorandum (OM).No. FEB.269/2017/27 dated 21.08.2019 vide online. The department will not entertain any claim for release of the E.M. during the pendency of selection of contractors for awarding the contract. The department will not pay any interest on the E.M. deposit.

iii) The E.M. is liable to be forfeited in the absolute discretion of the CGM(H&C), APGCL if the selected bidder revokes or alter or causes to withdraw his offer/tender before the expiry of its validity or fails after the contract is awarded to him to execute the 'Contract Agreement' with the department or to commence the work within the period envisaged in the terms and conditions or as might be notified in the work order.

iv) A tender is liable to outright rejection in absence of the requisite E.M. deposit.

#### 4. SECURITY DEPOSIT (S.D.) IN THE FORM OF PERFORMANCE BANK GUARANTEE

4.1 Performance Guarantee amounting to **10% of the quoted value by the successful bidders** must be deposited immediately after issue of Letter of Award/Work Order. The successful bidder will be issued letter of intent before allotment of Work Order and he/she must immediately initiate the process for issuance of Bank Guarantee with the concerned **Nationalized Bank** so as to ensure submission of PBG on the date of issuance of LoA/Work Order. The bidder may submit the requisite bid security only in the form of Bank Guarantee in favour of "**The Chief General Manager(F&A), APGCL, Bijulee Bhawan, Guwahati- 01**". Bid Security in any other form will not be accepted. The PBG submitted for Bid Security should have a **minimum validity of 24(twenty four months) i.e, 2(two) years.**

The bidders are requested to advise the Bank Guarantee issuing bank to comply with the following and ensure to submit, the receipt of the copy of SFMS messages as sent by the issuing bank branch, along with the original BG in APGCLs tender issuing office:

The bank guarantee issued by the **Nationalized Bank** must be routed through SFMS platform as per following details:

i. MT/IFN 760/MT/IFN 760 COV for issuance of Bank Guarantee.

ii. MT/IFN 760/MT/IFN 767 COV for amendment of Bank Guarantee.

The above message/intimation shall be sent through SFMS by the BG issuing Bank Branch to **AXIS Bank, Paltanbazar Branch, Account No: 375010200007573, IFS Code-UTIB0000375, Branch Address-**

**AXIS Bank Ltd., Commercial Building, A.T. Road, Guwahati-01.**

**Apart from Bank Guarantee, Performance Security Deposit can also be submitted through Fixed Deposit (FD) and Demand Draft (DD), pledged / drawn in favour of The Chief General Manager (F&A), APGCL. All other Terms & Conditions regarding the Performance Security Deposit shall remain the same as mentioned in the above paragraphs.**

4.2 Such S.D. shall be forfeited or appropriated by invocation of PBG by the CGM (H&C), APGCL, Bijulee Bhawan, Guwahati under authority of the owner in his discretion towards any loss, damage etc. that may be sustained by the APGCL as a result of breach of any terms, conditions of the contract by the contractor, notwithstanding other remedies open to the APGCL under the terms of the contract or law.

4.3 In the event of contractor's Security Deposit being appropriated towards loss, damage etc, the contractor shall forthwith recoup the amount to restore the Security Deposit to the full current value within 30 (thirty) days from the date of intimation.

4.4 Subject to the provisions mentioned above and the provisions of **guarantee period of one year**, the Security Deposit will be returned to the contractor on the due and satisfactory completion of the contract and after all claims of the APGCL shall have been settled. The APGCL will not pay any interest on the amount of Security Deposit of Performance Guarantee. If the work gets damaged during the defect liability period due to default of the contractor or even otherwise (including due to force majeure) the CGM (H&C) reserves the right to forfeit the SD Money. These points shall also be valid if SD is submitted through FD, DD.

**5. GST / INCOME TAX CERTIFICATE (PAN / GST):**

- 5.1 The offered rates and / or prices for the work shall include all taxes, duties, forest royalties, monopolies etc. as may be applicable on material and labour during the tenure of the contract. There will be no reimbursement for any increase or levy of new taxes, duties etc. on materials utilized for this work or equipment furnished / supplied for completing the work or for machineries, equipment, tools and tackle, fuel and lubricants etc. used in connection with the performance of the work, unless otherwise specified or qualified by the bidder in his bid. If, however, any tax or duty is levied by the Govt. or statutory body on the finished work (after complete installation and / or delivery), such tax or duty will be to the account of the APGCL.
- 5.2 The contractors must have an **Active GST Registration No. and should submit copy of GST Certificate and attested copy of PAN Card.**
- 5.3 **Caste certificate** must be produced where necessary.
- 5.4 **Copy of acknowledgment of ITR filled for preceding three financial years and an undertaking regarding ITR filling for preceding three financial years immediately before the FY in which tax is required to be deducted (i.e. for AY 2024-25, AY 2023-24 & AY 2022-23).**

**6. BIDDER'S QUALIFICATIONS:**

- 6.1 The Bidder should submit a list and description of similar or comparable works previously executed by him successfully during last 7 (seven) consecutive years indicating the individual volume and contract price along with the name and address of the respective owner / authority.
- 6.2 All prospective bidders are hereby notified that, before any bid submitted in response to this invitation is considered for award, the CGM (H&C) , APGCL may require the bidder to submit a further statement of facts in detail as to the previous experience of the bidder and financial resource available with him for performing the contemplated work. The CGM (H&C) , APGCL expressly reserves the right to reject any bid or which the facts as to business, financial and other resources or business experience, compared with the work bid upon, justify such rejection.
- 6.3 The Bidder should submit valid **Labour License Certificate**. The Bidder must possess Valid **Contractor License** issued by any department under Govt. of Assam
- 6.4 Cost overrun shall not be accepted.
- 6.5 Civil Engineering firms/contractors with adequate experience of having successfully completed **similar works during the last 7 years** ending last day of month previous to the one in which applications are invited should be either of the following:-
- a. Three similar completed works costing not less than the amount equal to **Rs. 41,80,337.00 (40% of the tendered amount)**.
- or**
- b. Two similar completed works costing not less than the amount equal to **Rs. 52,25,422.00 (50% of the tendered amount)**.
- or**
- c. One similar completed work costing not less than the amount equal to **Rs. 83,60,674.00 (80% of the tendered amount)**.  
(Supporting documents to be submitted).  
(Supporting documents to be submitted). They must submit such completion certificate along with the respective Work Order. Similar works shall pertain to works involving Construction of precast boundary wall. Completion Certificates must be submitted for all the executed works.
- 6.6 Contractors should be financially sound to invest the amount and should submit necessary evidence on this account. **CA certified Average Annual turnover during last three Financial Years i.e. 2023-24, 2022-23, 2021-22 should not be less Rs. 52,25,422.00 (50% of the tendered amount)**. However, annual turnover certificate of each of the three financial years mentioned above must be supported by Audited Financial Statements. The CA certified average annual turnover may be accompanied with relevant financial documents for the **FY 2023-24, 2022-23, 2021-22**.
- 6.7 It should be ensured that the contractors shall have **Provident Fund Code No.** It will be ascertained that all the workers engaged by the contractor directly should be registered for Employees' Provident (EPF) and due contribution have been credited into their account. The **Bidder should also submit valid ESIC Certificates.**



- 6.8 The bidder should have adequate **manpower and machinery**. The proper manpower and machinery list at the disposal of the contractor which is to be deployed at site should be **submitted in form of notarized affidavit**.
- 6.9 **The Bidder should have manufacturing facilities for such precast boundary walls and must submit valid Manufacturing license & Registration of Factories from Concerned Authority (Chief Inspector of Factories, Govt of Assam). The bid of the bidder is liable to be cancelled if the Manufacturing license & Registration of Factories from Concerned Authority (Chief Inspector of Factories, Govt of Assam) is not submitted along with the bid.**
- 6.10 **The Bidder should not have been blacklisted by any State Government, Central Government, State PSU, Central PSU, Private Company, etc. Document where the bidder has ‘solemnly’ stated that he has not been blacklisted by any State Government, Central Government, State PSU, Central PSU, any Private Organization, etc. Such document shall be Notarized.**
- 6.11 **Certified copy from Chartered Accountant for Net Worth of bidder for FY 2022-23 must be submitted.**
- 6.11. **Bank solvency certificate not earlier than past 01 year from the date of floating of the tender.** The date of issuance and amount should be clearly mentioned.
- 6.12. In the absence of the above stated requisite documents, the bid of bidder will be considered non-responsive.

7. **BIDDER SHOULD EXAMINE & UNDERSTAND**

All prospective bidders are required to thoroughly study and carefully examine all the terms and conditions, instructions, drawing & specifications pertaining to the work and visit the field of work to fully satisfy and acquaint themselves about the nature and location of work, the configuration of the ground. The spring level, the surface conditions, quality and quantity of materials required and their availability the type of equipment and facilities needed preliminary to and during the execution of the work and local conditions which may affect the work or cost thereof. Failure to do so will be at the bidder’s risk.

8. **SUBMISSION OF TENDER**

- 8.1 Bidders are to quote their rates against each item in clear money (Rupees) value per unit of work (inclusive of all taxes) in the prescribed format.
- 8.2 **The rates are to be quoted on item rate basis. The rates are to be quoted in figures.**
- 8.3 **The rates quoted by the bidders will be inclusive of all taxes, royalties and other statutory levies as applicable.**
- 8.4 **Bidders should note that unusually low rates not feasible for execution may not be technically accepted.**
- 8.5 Bidders should note that during the time of execution of work, any item not covered by the schedule of work if required to be done as per decision of the CGM (H&C) / Engineer-in Charge of APGCL, they have to execute such work/works as supplementary item of works, rates of which will be calculated by using the following formulae:

$$R = (T'/T) * P$$

Where, R= Rate of supplementary item of work

T'= Bid value

T= Tendered value

P= Accepted Rate for the work as per respective S.O.R. or estimate

If the rate of such supplementary item/items is/are not available in the aforesaid S.O.R, the same will be analyzed by the department as per reasonable market price but in any case, of dispute for rate of supplementary item/items, the decision of CGM (H&C) will be final and conclusive.

- 8.6 **The quoted rates will be firm for entire period of completion of the work. No price escalation on any component will be admissible.**
- 8.7 Firms submitting tender should enclose a certified copy of the Firm’s constitution and a certified copy of Power of Attorney authorizing a person to operate the tender and contract and should furnish full address of the partners and the persons holding power of attorney on behalf of the firm.

- 8.8 **Information regarding litigation, current or during the last five years, in which the Bidder is involved with APGCL/AEGCL/APDCL and with any other state or central PSU/department, must be furnished, if any in the prescribed format ( at Chapter VII).**
- 8.9 In the event of the date specified for bid receipt and opening being declared as a closed holiday for Purchaser's office, the due date for submission of bids and opening of bids will be the following working day at the appointed date and place.
- 8.10 The Corporation cannot be held responsible for non-receipt and postal delay.
- 8.11 **Every page of the tender document to be duly signed by the bidder.**
- 8.12 **Reverse bidding will be done for the work**
- 8.13 The contesting bidders must password protect the technical documents before uploading on the NIC portal. The password must be kept confidential and shared only with the concerned officials of APGCL. Also, the bidders shall submit a hard copy of the technical bids in the O/o the GM (Civil), HQ, APGCL. The password must be emailed to APGCL on the day of Technical Bid opening. The email Id to which the password is to be mailed is: [saurav.saikia@apgcl.org](mailto:saurav.saikia@apgcl.org)
- 8.14 For any query regarding the tender, bidder shall email at:  
[aswini.choudhury@apgcl.org](mailto:aswini.choudhury@apgcl.org)  
[hazarika.geetika@apgcl.org](mailto:hazarika.geetika@apgcl.org)

## **9. AWARD OF CONTRACT**

- 9.1 The contract will be awarded to that responsible bidder whose bid, confirming to the scheduled conditions of contract and specifications, will be most advantageous to the Department, price and other factors considered. An award mailed (or otherwise furnished) to the successful bidder will result in a binding contract without further action by either party. The CGM (H&C), APGCL does not bind itself to accept the lowest bid or any bid. As the interest of the Department may require, the right is reserved to reject any or all bids and to waive any minor informality or irregularity in bids received without assigning any reason thereof. Bid which are incomplete or which contain undesirable conditions are liable to rejection.
- 9.2 **APGCL will try to make timely payment of bills, but on unavoidable circumstances cannot guarantee timely payment of bills, for which no interest on the payable amount will be entertained.**

## **10. CONTRACT AGREEMENT**

- 10.1 The 'Contract agreement' (or Tender Agreement) for the works will be drawn up with the selected bidder/bidders within 7 (Seven) days of issue of the LoI and the contract documents will comprise as described herein before.
- 10.3 In a case where the selected bidder fails to commence the work as shall be notified in the work order or fails to execute the tender agreement with the CGM (H&C), APGCL as stipulated herein before; the CGM (H&C), APGCL reserves the right to claim loss, damage etc. and take appropriate action under the terms of this document or law including forfeiture of S.D

## **11. TOOLS & PLANTS**

- 11.1 The APGCL shall not furnish any tools & tackle, plants and equipment or such facilities for carrying out the work by the contractor (excluding hypothecation). The contractor shall arrange and maintain the equipment required for implementation of work all throughout the period of the contract.

## **12. MATERIALS & LABOUR**

- 12.1 All materials (this includes without limitation raw materials, parts, components etc.) and labour required for carrying out the work shall be arranged and furnished by the contractor all throughout the tenure of the contract and strictly conform to relevant IS Code (latest revision).
- 12.2 The intending tenderers should inspect the prospective sources of collection of raw materials and fully satisfy him about the quality of materials, availability of materials, lead, and mode of transportation. The Department shall not consider, after acceptance of the contract, to pay any extra charge for lead or any other reasons, in case the contractor found later on, to have misjudged, the quality/quantity of availability of such materials from the source of collection.

- 12.3 APGCL shall not issue any construction materials such as cement, reinforcement bar, or any other materials.
- 12.4 In connection with the performance of work throughout the tenure of the contract, the engagement of labour and payment therefore by the contractor shall conform to the statute, the pertinent law or act of the Central & State Govts, as well as rules, regulations and orders of the local authorities or statutory bodies, as may be in force from time to time.
- 12.5 The materials procured for the work by the contractor shall be placed at site properly for inspection of Engineer-in charge before utilization. Any defecting materials should be replaced immediately for which no extra charge will be payable to the contractor.

### **13. CHANGES IN QUANTITY AND ITEM**

- 13.1 The CGM (H&C), APGCL may at any time, by a written order make changes within the general scope of the contract, in any one or more of the following:

- Quantity of any item
- Alteration or omission of any item
- Addition of any item
- Alteration in drawings, designs or specifications

If any such change causes an increase or decrease in the cost of or the time required for performance of the contract, an equitable adjustment shall be made in the contract price or time schedule or both and the contract shall be modified in writing accordingly. Any claim by the contractor for adjustment under this clause must be asserted within 30 days from the date of receipt by the contractor of the notification of change: PROVIDED HOWEVER, that the CGM (H&C) if decides that the facts justify such action, may receive and act upon any such claim asserted at any time prior to final payment under the contract. Failure to agree to any adjustment shall be a dispute concerning a question of fact within the meaning of the disputes mentioned herein after. However, nothing in this clause shall excuse the contractor from proceeding with the contract as changed.

### **14. INSPECTION**

- 14.1 All works and all supplies (this term includes without limitation raw materials, parts, components, intermediate assemblies and end products) under the contract shall be subject to inspection and test by the CGM (H&C) , APGCL or his authorized person to the extent practicable at all times and places including the period of construction or manufacture and in any event prior to final acceptance.
- 14.2 In case any work or part thereof or/and any supply is found defective in material or workmanship or otherwise not in conformity with the specifications or drawings or requirements of the contract, the CGM (H&C), APGCL shall have the right either to reject them or to require their correction, as directed by the department.
- 14.3 The inspection and test by the CGM (H&C) , APGCL or his authorized person of any work or any supplies does not relieve the contractor from any responsibility regarding defects or other failures to meet the contract requirements which may be discovered prior to final acceptance. Except as otherwise provided in this contract final acceptance shall be conclusive except as regards latent defects, fraud or such gross mistakes as amount to fraud.
- 14.4 The contractor shall provide and maintain an inspection system acceptable to the CGM (H&C) , APGCL covering the works and/or supplies hereunder. Records of all inspection works by the contractor shall be kept complete and available to the CGM (H&C),APGCL during the performance of this contract.

### **15. FORCE MAJEURE**

- 15.1 Force Majeure shall cover only act of God, Fire, War, Strikes, Riots and Civil Commotion, Act of Government etc. Any constraints other than those specified above will not constitute force majeure condition. In view of the other constraint beyond the control of the Contractor primarily due to statutory compulsion, extension of execution may also be considered on individual merit of the case. In case of Force Majeure condition the contractor shall notify such condition to CGM (H&C) within 15 (fifteen) days from the beginning of such delay in writing for consideration and acceptance.
- 15.2 It may be noted that in the event of Geological surprises/problems, the work may need to be stopped for some time at the discretion of the engineer in charge. The stoppage period shall be

excluded from the time period allotted for completion of the work. The time of completion shall be accordingly adjusted for such stoppage of work, if any.

**16. LIQUIDITY DAMAGE**

16.1 In case of delay in work completion beyond the work completion period, the contractor shall be liable to the following:

a) The liquidated damages shall be payable for delay in completion of the work @ 1 % (one percent) of the executed value per week. The liquidated damages so payable shall not exceed 10% (ten percent) of the executed value. However, the payment of liquidated damages shall not in any way relieve the Contractor from any of its obligations to complete the works or from any other obligations and liabilities of the Contractor under the Contract.

b) Complete the balance work giving notice to the Contractor and to recover any extra expenditure incurred thereby for having to purchase these materials or complete the work at a higher price, at risk and responsibility of the Contractor.

c) Cancel the Contract/Work Order wholly or in part and to purchase materials/equipment and execute the work at the full risk and cost of the Contractor and forfeit the security deposit.

d) The work is liable to be stand cancelled without any compensation, if the work is not completed within 180 days from the end date of the contractual completion date as per work order.

**17. TERMS OF PAYMENT**

1) 1<sup>st</sup> Running Account Bill shall be entertained only after completion of minimum 25% of total work.

2) 2<sup>nd</sup> Running Account Bill shall be entertained only after completion of minimum 50% of total work.

2) 3<sup>rd</sup> Running Account Bill shall be entertained only after completion of minimum 75% of total work.

3) 4<sup>th</sup> & Final Account Bill shall be entertained only after completion of 100 % of total work.

5) Bills shall be entertained on the basis of actual measurement of completed work as per standard procedure.

6) Every payment shall be made subject to the availability of fund.

**18. CONTRACTUAL FAILURE:**

In the event of contractual failure of any respect on the part of the Contractor, APGCL shall be entitled to forfeit the security deposit or any deposit or any payment due to the Contractor from this or his other contracts towards the recovery of APGCL's claim for damages arising out of the failure. In addition, APGCL may black-list or ban the Contractor or pending enquiry, suspend him or take any other steps considered suitable.

**19. SETTLEMENT OF DISPUTE:**

In the event of any dispute or differences at any time arising between the parties relating to work or any other clauses or any content of the right and liabilities of the parties or other matters specified therein or with reference to anything arising out of the such dispute or differences shall be endeavored to be resolved by mutual negotiation. If, however, such negotiation is infructuous, the dispute should be finally settled through Arbitration and Conciliation Act 1996 and its amendments thereof. The arbitration proceedings shall be held in Guwahati.

**20. TERMINATION:**

20.1 APGCL may, by not less than 7 (seven) days written notice may terminate the contract, if the contractor:

i. Fails to remedy a failure in the performance of his obligations,

- ii. Becomes insolvent or bankrupt,
  - iii. Submit to APGCL statement which has a material effect on the rights, obligations or interest of APGCL and which the contractor known to be false,
  - iv. As result of force majeure, if the whole work cannot be performed for a continuous period of 90 (ninety) days. APGCL shall make payment upon termination to contractor the services performed by the contractor to the entire satisfaction of APGCL prior to date of termination.
- 20.2 If the work remains unfinished even beyond 180 days of Contractual completion date for the work without any valid reason/ justification, in that case the Work Order for the work will automatically be cancelled along with termination of the work and putting the Contractor on Holiday List for a period of 5(five) years.

**21 REJECTION:**

In the event, any of the materials supplied by the Contractor or work executed is found defective or otherwise not in conformity with the requirements of the contract/tender specifications, APGCL shall either reject the material/work or request the Contractor in writing to rectify the same. The Contractor, on receipt of such notification shall rectify or replace the defective material/rectify the defective work free of cost to APGCL. If the Contractor fails to do so, APGCL may at its option:-

- (a) Replace or rectify such defective/non-conforming material/correct the defective work and recover the extra cost so involved plus 15% as overhead charge from the Contractor, or
- (b) Terminate the contract for default.

**22. DEATH , BANKRUPTCY ETC.**

If the Contractor becomes bankrupt or being a corporation is in the process of winding up, amalgamation or reorganization, then APGCL shall be at liberty to: -

- (A) Terminate the contract forthwith by notice in writing to the Contractor or to the liquidator or receiver or to any person in whom the contract may become vested.
- (B) Give such liquidator, receiver or other person the option of carrying out the contract subject to his providing a guarantee for the due and faithful performance of the contract up to an amount to be determined by APGCL. In case of death of the Contractor before completion of work and supply, then APGCL shall be at liberty to:
  - (a) Close up the contract and take over the completed portion of work/supply done and made as per specification and make final payment to the legal heir of the Contractor on receipt of claim from such legal heir.
  - (b) Give the contract to the legal heir of the Contractor subject to his depositing a performance security for the due and faithful performance of the contract. The performance security amount shall be determined by APGCL commensurate with the incomplete portion of the work/supply. APGCL will enter into a fresh contract with the legal heir of the Contractor on the same terms and conditions of the earlier contract.

**23. PRECAUTION TO BE TAKEN DURING EXECUTION OF WORK:**

The Contractor shall take responsible for statutory precaution during execution of the work at work site so as to avoid accident and damage to equipment and injury to workman and to prevent theft, pilferage etc.

**24. LIABILITY FOR ACCIDENT AND DAMAGE:**

The Contractor shall not claim for compensation arising out of any accident(s) or damages done during the course of work execution at work site & the Contractor will be responsible for paying compensation to the worker as per Workmen Compensation Act, 1923 and subsequent amendments thereof. It is further clarified that in case any payment is to be made by the Contractor under the said Workmen Compensation Act, the same shall be paid forthwith and in case of failure in making such payments APGCL shall make payment and the amount so paid shall be deducted from the bills of the Contractor.

**25. VALIDITY OF OFFER**

The Offer shall be valid for a period of 180 days from the date of submission of the bid by the bidder. However, the bidder may be required to extend the validity of bid if sought by APGCL.

**26. CO-OPERATION WITH OTHER CONTRACTORS**

The Contractor shall agree to co-operate with the APGCL's other contractors for associated supplies and freely exchange with them such technical information as is necessary to obtain the most efficient and economical design and to avoid unnecessary duplication. No remuneration shall come from APGCL for such technical co-operation.

**27. SUBLETTING CONTRACT:**

The Contractor shall not, without the consent in writing of APGCL assign or sublet his contract, or any substantial part thereof, or interest therein of benefit or advantage whatsoever, other than for raw materials or for minor details or for any part of the work of which the Sub-contractors are named in the tender provided any such consent shall not relieve the Contractor from any obligation, duty or responsibility under the contract.

**28. DEDUCTION FROM CONTRACT PRICE:**

All cost, damages or expenses which APGCL may have made for which, under the contract, the Contractor is liable, may be deducted by APGCL from any money due or becoming due by APGCL to the Contractor or may be recovered by action at law or otherwise from the Contractor. In the event of recovery to the necessary extent becoming impossible owing to insufficiency of the earnest money/security deposit and withheld amounts, the balance due to APGCL may at the option of APGCL be recovered from any money due to the Contractor from APGCL under other contracts with the Contractor.

**29. REGULATION OF LOCAL AUTHORITIES:**

The Contractor shall abide by the regulation of local Authorities unless such regulation is repugnant to any terms of the contract agreed upon. The Contractor is required to fulfill all criteria related to Labour Laws. The Contractor will also comply with all regulations/ directives of both State & Central Government Pollution Boards.

**Royalties on minor minerals shall be deducted as per the GoA Notification No.PEM.130/2021/40 dated 7th October, 2021.**

**30. SUSPENSION OF BUSINESS DEALINGS WITH FIRM/CONTRACTOR:**

APGCL may suspend business dealings with a Firm/ Contractor, if: (a) The Central Bureau of Investigation or any other investing agency recommends such a course in respect of a case under investigation; and if a prima facie case is made out that the firm is guilty of an offence involving unethical, unlawful, fraudulent means in relation to business dealings, which, if established, would result in business dealings with it being banned. (b) APGCL has past record of non-performance of the Firm in it's previously awarded contracts. (c) APGCL has record of ban against the Firm by other Government / Public sector utility. (d) However, APGCL shall give the Firm/Contractor a fair chance to explain the circumstances of such previous suspensions.

**31. BANNING OF BUSINESS DEALINGS WITH FIRMS/CONTRACTORS:**

APGCL may ban business dealings with a Firm/Contractor, if:

- a) The owner (s) of the Firm/Contractor is convicted by a court of law following prosecution for offenses involving unethical, unlawful, fraudulent means in relation to business dealings.
- b) There is strong justification that the Firm has been guilty of malpractices, such as, bribery, corruption, fraud, substitution of tenders, interpolation, misrepresentation, evasion or habitual default in payment of any Government tax etc.
- c) The Firm continuously refuses to return government dues without showing adequate cause and Government are reasonably satisfied that this is not due to reasonable dispute which would attract proceeding in arbitration or court of law.
- d) The Firm is found guilty of involving in unethical practices, such as:

1. "Corrupt practice" involving offering, giving, receiving or soliciting, directly or indirectly, of any thing of value to influence the action of any such official procurement process or in contract execution.
2. "Fraudulent practice" involving misrepresentation or omission of facts in order to influence a procurement process or the execution of a contract to the detriment of the Employer.
3. "Collusive practice" involving a scheme among bidders (prior to or after submission) designed to establish bid prices at artificial non-competitive levels and to deprive the Employer of the benefits of free and open competition.
4. "Coercive practice" involving harming or threatening to harm directly or indirectly, persons or their property to influence procurement process or the execution of a contract. APGCL may sanction a Firm/ Contractor or its successor, including declaring ineligible, indefinitely or for a period of not less than 3 (three) years

**32. BID EVALUATION CRITERIA:**

**a. Techno-commercial Part:**

- i. The Techno-commercial Part of bid shall be evaluated as per clauses stipulated in this tender document and as per instructions laid down in the document "General Condition for Supply and Erection of APGCL, 2014".
- ii. Bidders must ensure that complete bid along with all details & documents as sought are submitted as per requirements of this tender document.
- iii. If any of the clauses of the Tender contradict the clauses of the document- "General Condition for Supply & Erection, 2014" of APGCL, then those stated in this Tender shall prevail.

**b. Price Part.**

The quoted price inclusive of all components shall be considered during price bid evaluation. The bidder must clearly specify all tax & duties levied etc., in the absence of which the same shall be at bidder's scope.

## CHAPTER-IV

### SAFETY ENGINEERING & SAFETY CODE

#### 1. SAFETY ENGINEERING:

Accident prevention shall be an essential part of the programme of the contractor for all operations involved in performance of the contract under this invitation in order to reduce cost of construction measured in terms of:

Near Miss Accidents

Accidents

Temporary injury

Permanent injury

Fatal accident

- b) Loss of materials resulting from accidents
- c) Loss of damage to equipment.
- d) The cost of work man's compensation insurance.
- e) Loss of time due to accident, ultimately leading to downtime reduction.

Suitable safety programme should be developed to cope with the particular hazard for each operation.(Operation & maintenance).

#### GENERAL SAFETY PROGRAMME:

The following program when vigorously promoted by the works- management may be effective in reducing the accident rate

- a) Secure full support from top management of concerned divisions or sections
- b) Publicize safety programme
- c) Develop a safety programme for each job.
- d) Maintain adequate first aid facilities
- e) Make safety practices effective.
- f) All safety ropes, **PPE (Personal Protective Equipment)**, harness, boots, gloves/insulated gloves for electrical works, helmets and First AID Box required for the work have to be supplied by the contractor at his own expense.

#### SAFETY CODE:

An effective measure of reducing the accident rate during various operations and maintenance works may consist in implementation of respective provisions of the following safety codes accompanied by vigorous promotion and publicity of safety programme.

- a) IS: 818 (C.P. for safety health requirements in electric & gas welding & cutting operations).
- b) IS: 3696(S.C for scaffolding & ladders)
- c) IS: 7205 (S.C for erection of structural steel work)

#### SAFETY EQUIPMENT'S:

All necessary personnel safety equipment as considered adequate by the Engineer-in- Charge should be kept available for use of the persons employed on the site and maintain in a condition suitable for immediate use. The contractor should take adequate steps to ensure proper use of equipment by those concerned

Those engaged in welding works shall be provided with welder's protective eye-shield. Suitable protective foot ware, protective head gears, suitable face masks etc. are to be provided to workers engaged for operation and maintenance works. The contractor shall not employ men below the age of 18 for any work.

#### 2. INSPECTION

To ensure effective enforcement of the rules and regulations relating to safety precautions, the arrangements made by the contractor shall be open to inspection by the Engineer-in-Charge or his representative.

#### 3. COMPENSATION



No extra charges or additional compensation will be admissible to the contractor by the department for any work done to comply with the provisions of safety Engineering and Safety Code.

## **CHAPTER-V**

### **CONTRACTOR'S CAMP**

#### **1. CAMP SITES**

The contractor shall provide, maintain and operate under competent direction such camp facilities convenient to the site works under this contract as are necessary for housing, feeding and accommodation of his employees. The location, construction, operation and maintenance of such camps shall be subject to the approval of the Assistant General Manager/ Engineer in charge of the site.

#### **2. USE OF LAND FOR CONSTRUCTION PURPOSES**

Such land as may be available at work- site will be allowed to be used by the contractor for construction of his camps free of charge. However, development of clearances of the land will have to be done by the contractor at his own cost. The contractor will be responsible to clear and clean the site after completion of his works and handover the land to the Engineer-in-Charge. The contractor will be liable to pay compensation for any damages done to the land or neighboring area.

#### **3. SANITATION IN CAMP SITE:**

The temporary sanitation in the campsite should be properly maintained and hygienic so that pollution can be controlled and just before completion of the work site must be cleared properly.

#### **4. ELECTRICITY SUPPLY:**

Electricity supply will be on a chargeable basis.

**CHAPTER-VI**

**DECLARATION**

I / We hereby declare that I/we shall treat the tender documents and other records connected with the works as secret/confidential and shall not communicate information derived there from to any person other than person to whom I//We/am/are authorized to communicate the same or use the information to any manner prejudicial to the safety of the state.

Signature of the tenderer

Full Name

(In Block letters)

Address .....

Phone/ Mobile .....

Email: .....

Date: .....

Bank name: .....

Bank A/C no. & IFSC: .....

\* this page must be filled by the bidder

CHAPTER-VII

DECLARATION OF LITIGATION

Information on litigation history in which bidder is involved.  
( To be filled by the bidder)

Employer (APDCL/APGCL/AEGCL and with any other state or central PSU/department)	Cause of Dispute	Amount involved	Remarks showing present status

## CHAPTER-VIII

### Schedule of work:

ANNEXURE-A

To,

The Chief General Manager (Hydro & Civil)  
APGCL, Bijulee Bhawan,  
Paltanbazar, Guwahati-1

Sub: Submission of tender for the work: Construction of precast boundary wall for length of 701 M in the eastern side of NTPS, APGCL. , Namrup, District:- Dibrugarh.

Ref: Your E-NIT: .....

Dear Sir,

In response to your above notice I/We ..... am /are submitting herewith, my / our rates for the work as mentioned below. Necessary documents, as asked for, are enclosed herewith, for your kind perusal.

**Name of work:** Construction of precast boundary wall for length of 701 M in the eastern side of NTPS, APGCL, Namrup, District:- Dibrugarh.

#### **Part A: For 660 M**

Sl. No.	Description of Item	Quantity	Unit	Rate (Rs.) Including all taxes	Amount (Rs) Including all taxes
1	Earth work in excavation by mechanical means (Hydraulic excavator) / manual means in foundation trenches or drains (not exceeding 1.5 m in width or 10 sqm on plan), including dressing of sides and ramming of bottoms, lift upto 1.5 m, including getting out the excavated soil and disposal of surplus excavated soil as directed, within a lead of 50 m. All kinds of soil.	311.375	cum		
2	Brick work with common burnt clay F.P.S. (non modular) bricks of class designation 7.5 in foundation and plinth in: Cement mortar 1:4 (1 cement : 4 coarse sand)	19.875	cum		
3	Providing and laying in position cement concrete of specified grade excluding the cost of centering and shuttering - All work up to plinth level: 4.1.5 1:3:6 (1 Cement : 3 coarse sand (zone-III) derived from natural sources : 6 graded stone aggregate 20 mm nominal size derived from natural sources) PCC Foundation Regular post .	26.5	cum		

4	Steel reinforcement for R.C.C. work including straightening, cutting, bending, placing in position and binding all complete upto plinth level. Thermo-Mechanically Treated bars of grade Fe-500D or more. Steel reinforcement for R.C.C. work including straightening, cutting, bending, placing in position and binding all complete above plinth level. Thermo-Mechanically Treated bars of grade Fe-500D or more	20082.18	kg		
5	Centering and shuttering including strutting, propping etc. and removal of form for Foundations, footings, bases of columns, etc. for mass concrete	789.700	sqm		
6	Centering and shuttering including strutting, propping etc. and removal of form for lintels, beams, plinth beams, girders, bressummers and cantilevers	2313.99	sqm		
7	Providing and laying in position ready mixed or site batched design mix cement concrete for reinforced cement concrete work; using coarse aggregate and fine aggregate derived from natural sources, Portland Pozzolana / Ordinary Portland /Portland Slag cement, admixtures in recommended proportions as per IS: 9103 to accelerate / retard setting of concrete, to improve durability and workability without impairing strength; including pumping of concrete to site of laying, curing, carriage for all leads; but excluding the cost of centering, shuttering, finishing and reinforcement as per direction of the engineer-in-charge; for the following grades of concrete. Note: Extra cement up to 10% of the minimum specified cement content in design mix shall be payable separately. In case the cement content in design mix is more than 110% of the specified minimum cement content, the contractor shall have discretion to either re-design the mix or bear the cost of extra cement.	105.828	cum		

	A) All works upto plinth level  i) Concrete of M25 grade with minimum cement content of 330 kg /cum				
8	Providing and laying in position ready mixed or site batched design mix cement concrete for reinforced cement concrete work; using coarse aggregate and fine aggregate derived from natural sources, Portland Pozzolana / Ordinary Portland /Portland Slag cement, admixtures in recommended proportions as per IS: 9103 to accelerate / retard setting of concrete, to improve durability and workability without impairing strength; including pumping of concrete to site of laying, curing, carriage for all leads; but excluding the cost of centering, shuttering, finishing and reinforcement as per direction of the engineer-in-charge; for the following grades of concrete. Note: Extra cement up to 10% of the minimum specified cement content in design mix shall be payable separately. In case the cement content in design mix is more than 110% of the specified minimum cement content, the contractor shall have discretion to either re-design the mix or bear the cost of extra cement. A) All works upto plinth level i) Concrete of M25 grade with minimum cement content of 330 kg /cum	103.269	cum		
9	Structural steel work riveted, bolted or welded in built up sections, trusses and framed work, including cutting, hoisting, fixing in position and applying a priming coat of approved steel primer all complete.	10151.391	kg		
10	Applying priming coats with primer of approved brand and manufacture, having low VOC (Volatile Organic Compound) content. With water thinnable cement primer on wall surface having	3432.175	sqm		

	VOC content less than 50 grams/litre				
11	Finishing walls with water proofing cement paint of required shade : 13.44.1 New work (Two or more coats applied @ 3.84 kg/10 sqm)	3432.175	sqm		
12	Painting with synthetic enamel paint of approved brand and manufacture of required colour to give an even shade : Two or more coats on new work over an under coat of suitable shade with ordinary paint of approved brand and manufacture	559.150	sqm		
13	Fencing with angle iron post placed at required distance embedded in cement concrete blocks, every 15th post, last but one end post and corner post shall be strutted on both sides and end post on one side only and provided with horizontal lines and two diagonals interwoven with horizontal wires, of barbed wire weighing 9.38 kg per 100 m (minimum), between the two posts fitted and fixed with G.I. staples, turn buckles etc. complete. (Cost of posts, struts, earth work and concrete work to be paid for separately). Payment to be made per metre cost of total length of barbed wire used. With G.I. barbed wire	5280.00	meter		
14	Hydraulic excavator of 1 cum bucket (inclusive of GST, CP and contractors over head)	40.0	hour		
15	Mobile crane	25.0	days		
16	Hire charges of Diesel Truck - 9 tonne (with POL)	15.0	days		

**Part B: Gate**

Sl. No.	Description of Item	Quantity	Unit	Rate (Rs.) Including all taxes	Amount (Rs) Including all taxes
1	Earth work in excavation by mechanical means (Hydraulic excavator) / manual means in foundation trenches or drains (not exceeding 1.5 m in width or 10 sqm on plan), including dressing of sides and ramming of bottoms, lift upto 1.5 m, including getting out the excavated soil and disposal of surplus excavated soil as directed,	11.055	Cum		

	within a lead of 50 m . All kinds of soil				
2	Brick work with common burnt clay F.P.S. (non modular) bricks of class designation 7.5 in foundation and plinth in: Cement mortar 1:4 (1 cement : 4 coarse sand)	0.741	Cum		
3	Providing and laying in position cement concrete of specified grade excluding the cost of centering and shuttering - All work up to plinth level. 1:3:6 (1 Cement : 3 coarse sand (zone-III) derived from natural sources : 6 graded stone aggregate 20 mm nominal size derived from natural sources)	0.695	Cum		
4	Steel reinforcement for R.C.C. work including straightening, cutting, bending, placing in position and binding all complete upto plinth level and above plinth level. Thermo-Mechanically Treated bars of grade Fe-500D or more.	303.093	kg		
5	Centering and shuttering including strutting, propping etc. and removal of form work for Foundations, footings, bases for columns etc. for mass concrete	6.78	Sqm		
6	Centering and shuttering including strutting, propping etc. and removal of form work for lintels, beams, plinth beams, girders, bressumers and cantilevers	6.60	Sqm		
7	Centering and shuttering including strutting, propping etc. and removal of form work for columns, piers, abutments, posts and struts	11.00	Sqm		
8	Providing and laying in position specified grade of reinforced cement concrete, excluding the cost of centering, shuttering, finishing and reinforcement - All work up to plinth level : 1:1.5:3 (1 cement : 1.5 coarse sand (zone-III) derived from natural sources : 3 graded stone aggregate 20 mm nominal size de rived from natural sources)	3.011	Cum		
9	Reinforced cement concrete work in walls (any thickness), including attached pilasters, buttresses, plinth and string courses, fillets, columns, pillars, piers, abutments, posts and struts etc. above plinth level up to floor five level, excluding cost of centering, shuttering, finishing and reinforcement : 1:1.5:3 (1 cement : 1.5 coarse sand(zone-III) derived from natural sources : 3 graded stone aggregate 20 mm nominal size derived from natural sources)	0.763	Cum		
10	Brick work with common burnt clay F.P.S. (non modular) bricks of class designation 7.5 in superstructure above plinth level up to floor V level in all shapes and sizes in : Cement mortar 1:4 (1 cement : 4 coarse sand)	2.508	Cum		
11	Cement plaster (in fine sand) :12 mm cement plaster of mix 1:4 (1 cement: 4 fine sand)	36.0	Sqm		
12	Applying priming coats with primer of approved brand and manufacture, having low VOC (Volatile Organic Compound) content.	35.0	Sqm		



	With water thinnable cement primer on wall surface having VOC content less than 50 grams/litre				
13	Finishing walls with water proofing cement paint of required shade :New work (Two or more coats applied @ 3.84 kg/10 sqm)	35.0	Sqm		
14	Steel work welded in built up sections/ framed work, including cutting, hoisting, fixing in position and applying a priming coat of approved steel primer using structural steel etc. as required.  In gratings, frames, guard bar, ladder, railings, brackets, gates and similar works	508.918	kg		
15	Structural steel work riveted, bolted or welded in built up sections, trusses and framed work, including cutting, hoisting, fixing in position and applying a priming coat of approved steel primer all complete.	125.90	kg		
16	Painting with synthetic enamel paint of approved brand and manufacture to give an even shade : Two or more coats on new work	17.56	Sqm		
17	Fencing with angle iron post placed at required distance embedded in cement concrete blocks, every 15th post, last but one end post and corner post shall be strutted on both sides and end post on one side only and provided with horizontal lines and two diagonals interwoven with horizontal wires, of barbed wire weighing 9.38 kg per 100 m (minimum), between the two posts fitted and fixed with G.I. staples, turn buckles etc. complete. (Cost of posts, struts, earth work and concrete work to be paid for separately). Payment to be made per metre cost of total length of barbed wire used. With G.I. barbed wire	56.0	Metre		

**Part C: River portion 30 M**

Sl. No.	Description of Item	Quantity	Unit	Rate (Rs.) Including all taxes	Amount (Rs) Including all taxes
1	Earth work in excavation by mechanical means (Hydraulic excavator) / manual means in foundation trenches or drains (not exceeding 1.5 m in width or 10 sqm on plan), including dressing of sides and ramming of bottoms, lift upto 1.5 m, including getting out the excavated soil and disposal of surplus excavated soil as directed, within a lead of 50 m .All kinds of soil	61.56	Cum		
2	Random rubble masonry with hard stone in foundation and plinth including levelling up with cement concrete 1:6:12 (1 cement : 6 coarse sand : 12 graded stone aggregate 20 mm nominal size) upto plinth level with : Cement mortar 1:6 (1 cement : 6 coarse sand)	12.312	Cum		

3	Providing and laying in position cement concrete of specified grade excluding the cost of centering and shuttering - All work up to plinth level. 1:3:6 (1 Cement : 3 coarse sand (zone-III) derived from natural sources : 6 graded stone aggregate 20 mm nominal size derived from natural sources)	2.448	Cum		
4	Steel reinforcement for R.C.C. work including straightening, cutting, bending, placing in position and binding all complete upto plinth level and above plinth level. Thermo-Mechanically Treated bars of grade Fe-500D or more.	1198.870	kg		
5	Centering and shuttering including strutting, propping etc. and removal of form work for Foundations, footings, bases for columns etc. for mass concrete	35.40	Sqm		
6	Centering and shuttering including strutting, propping etc. and removal of form for lintels, beams, plinth beams, girders, bressumers and cantilevers	81.0	Sqm		
7	Centering and shuttering including strutting, propping etc. and removal of form for columns, piers, abutments, posts and struts	66.72	Sqm		
8	Providing and laying in position specified grade of reinforced cement concrete, excluding the cost of centering, shuttering, finishing and reinforcement - All work up to plinth level : 1:1.5:3 (1 cement : 1.5 coarse sand (zone-III) derived from natural sources : 3 graded stone aggregate 20 mm nominal size de rived from natural sources)	16.329	Cum		
9	Reinforced cement concrete work in walls (any thickness), including attached pilasters, buttresses, plinth and string courses, fillets, columns, pillars, piers, abutments, posts and struts etc. above plinth level up to floor five level, excluding cost of centering, shuttering, finishing and reinforcement : 1:1.5:3 (1 cement : 1.5 coarse sand(zone-III) derived from natural sources : 3 graded stone aggregate 20 mm nominal size derived from natural sources)	9.495	Cum		
10	Brick work with common burnt clay F.P.S. (non modular) bricks of class designation 7.5 in superstructure above plinth level up to floor V level in all shapes and sizes in : Cement mortar 1:4 (1 cement : 4 coarse sand)	14.063	Cum		
11	Cement plaster (in fine sand) :12 mm cement plaster of mix 1:4 (1 cement: 4 fine sand)	159.80	Sqm		
12	Structural steel work in single section, fixed with or without connecting plate, including cutting, hoisting, fixing in position and applying a priming coat of approved steel primer all complete.	903.64	Kg		
13	Structural steel work riveted, bolted or welded in built up sections, trusses and framed work, including cutting, hoisting, fixing in position and applying a priming coat of approved steel primer	536.348	kg		

	all complete.				
14	Painting with synthetic enamel paint of approved brand and manufacture to give an even shade : Two or more coats on new work	61.342	Sqm		
15	Fencing with angle iron post placed at required distance embedded in cement concrete blocks, every 15th post, last but one end post and corner post shall be strutted on both sides and end post on one side only and provided with horizontal lines and two diagonals interwoven with horizontal wires, of barbed wire weighing 9.38 kg per 100 m (minimum), between the two posts fitted and fixed with G.I. staples, turn buckles etc. complete. (Cost of posts, struts, earth work and concrete work to be paid for separately). Payment to be made per metre cost of total length of barbed wire used. With G.I. barbed wire	240.0	Metre		
16	Applying priming coats with primer of approved brand and manufacture, having low VOC (Volatile Organic Compound) content. With water thinnable cement primer on wall surface having VOC content less than 50 grams/litre	125.0	Sqm		
17	Finishing walls with water proofing cement paint of required shade :New work (Two or more coats applied @ 3.84 kg/10 sqm)	125.0	Sqm		

**CHAPTER-IX**

<b>BIDDER'S CREDENTIALS</b>		
<b>Particulars</b>	<b>Validity period</b>	<b>Supporting documents</b>
<ol style="list-style-type: none"><li>1. Financial status (Average Annual Turnover for the F.Y. 2023-24, 2022-23 &amp; 2021-22).</li><li>2. Certified copy from Chartered Accountant for Net Worth of bidder for FY 2022-23.</li><li>3. PAN</li><li>4. Active GST Registration certificate</li><li>5. Registration certificate of firm (if any)</li><li>6. Labour License</li><li>7. E.P.F</li><li>8. List of similar works previously executed.</li><li>9. ITR return for <b>AY 2024-25, AY 2023-24 &amp; AY 2022-23</b></li><li>10. Manufacturing license &amp; Registration of Factories</li><li>11. Manpower &amp; machinery list in notarized form</li><li>12. ESIC</li><li>13. Valid Contractor license.</li><li>14. Bank solvency certificate.</li><li>15. OTHERS (Blacklisting) in notarized form</li></ol>		
<p>Note: 1) Bidder should furnish supporting documents. Otherwise, information given in the tender shall not be considered for evaluation.</p>		

Enclose:

Yours faithfully,

1. Demand Draft No.

2. Date of issue

3. Name of Bank

Signature of contractor

Full Name :

# CHAPTER-X DRAWINGS

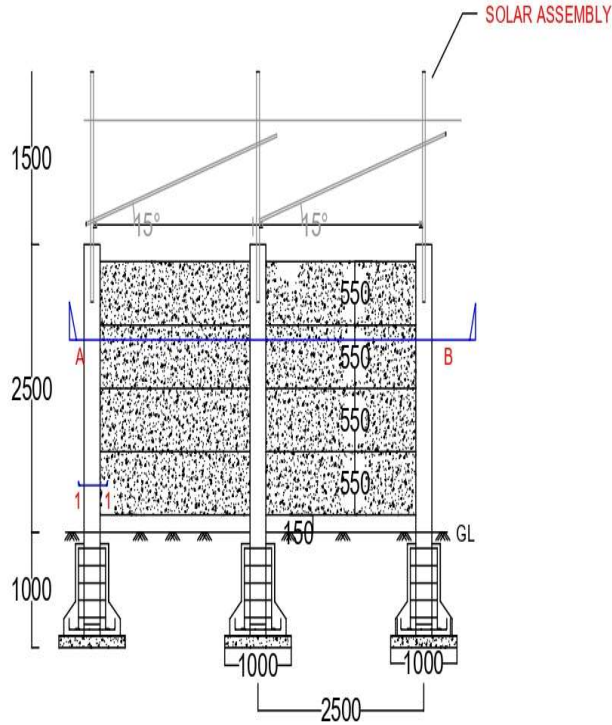

TYPICAL PLAN OF THE PRECAST BOUNDARY WALL

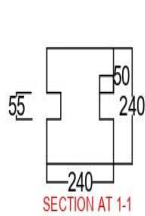

SECTION AT 1-1

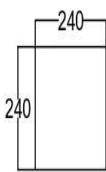

SECTION AT 2-2

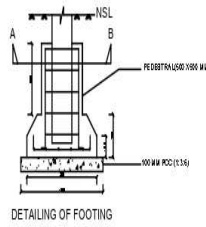

DETAILING OF FOOTING

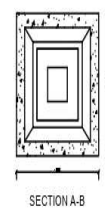

SECTION A-B

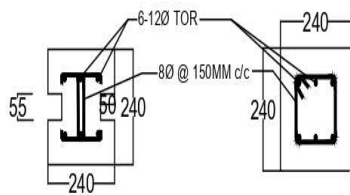

REINFORCEMENT DETAILING OF COLUMN

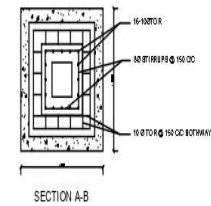

SECTION A-B

**NOTES:**

1. ALL DIMENSIONS ARE IN MILLIMETERS UNLESS STATED OTHERWISE
2. COLUMNS & PANELS SHOULD BE PRECASTED AND TO BE ERECTED IN POSITION AFTER GAINING FULL STRENGTH
3. CAPS ARE TO BE CAST IN SITU AFTER PANEL LIFTING IN COLUMNS
4. THE OUTER EDGE OF BOUNDARY WALL SHOULD BE AS PER THE PROVISION OF PARA 1047 OF INDIAN RAILWAY CODE FOR THE ENGINEERING DEPARTMENT
5. ALL RCC WORKS SHALL BE IN MIX M25 AS PER IS 456-2000
6. DESIGN MIX OF M25 MAY BE VERIFIED BY EIC
7. PROPER CURING OF CONCRETE SHALL BE ENSURED
8. ALL CONCRETE SHALL BE MECHANICALLY MIXED VIBRATED
9. COVER TO THE REINFORCEMENT SHALL NO WHERE BE LESS THAN AS SHOWN ON PLAN OR AS PER SPECIFIED IN IS 456-2000
10. HIGH WELD STRENGTH COLD TWISTED DEFORMED BARS SHALL CONFORM TO IS 1786-1985
11. PARTICULAR CARE MUST BE TAKEN TO ENSURE
  - i) NO SAG OCCURS IN REINFORCING BAR DURING CONSTRUCTION
  - ii) STIRRUPS ARE EFFECTIVELY TIED WITH WIRE TO THE MAIN REINFORCEMENT
12. SAFE BEARING CAPACITY OF SOIL IS ASSUMED AS 6TM<sup>2</sup>
13. THE POCKETS OF FOUNDATION SHALL BE MADE ROUGH TO HAVE GOOD BOND WITH FRESH CEMENT GROUT. ADDITIVES MAY BE USED WHEN REQUIRED
14. 50MM DIA HOLES PROVIDED IN THE PRECAST PANEL FOR LIFTING SHALL BE FILLED WITH CEMENT GROUT AFTER PLACING IN POSITION.
15. ANY DISCREPANCIES IF NOTICED MAY BE BROUGHT TO THE NOTICE OF EIC OR DESIGNER.

CONSTRUCTION OF PRE CAST BOUNDARY WALL FOR LENGTH OF 701 M IN EASTERN SIDE OF NTPS

TYPICAL SECTION OF PRECAST WALLS, FOOTINGS & COLUMNS

DESIGNED BY:	CHECKED BY:	APPROVED BY:
DATE	SEPTEMBER 2024	

*Baykari*

*Chandra et. bony*

Asstt. General Manager  
Namrup Civil Division  
NTPS, APGCL, Namrup

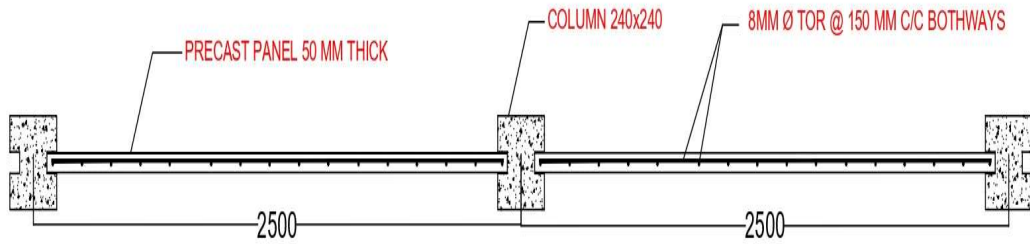

SECTION AT A-B

CONSTRUCTION OF PRE CAST BOUNDARY WALL FOR LENGTH OF 701 M IN EASTERN SIDE OF NTPS		
TYPICAL SECTION OF PRECAST WALLS, FOOTINGS & COLUMNS		
DESIGNED BY:	CHECKED BY:	APPROVED BY:
DATE	SEPTEMBER 2024	

*Signature*

*Signature*

*Signature*  
(Chandra K. Bork)

Asstt. General Manager  
Namrup Civil Division  
NTPS, APGCL, Namrup

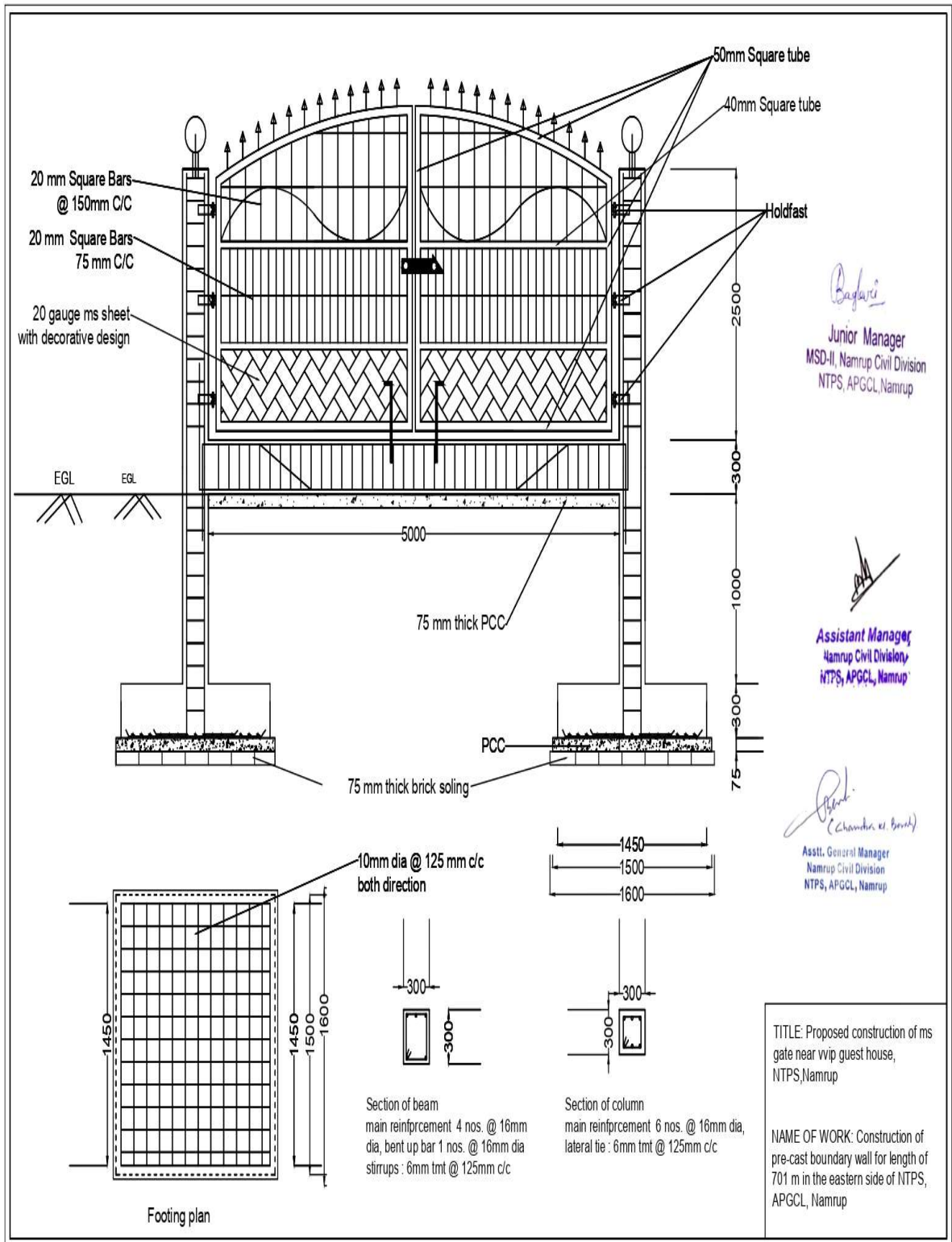

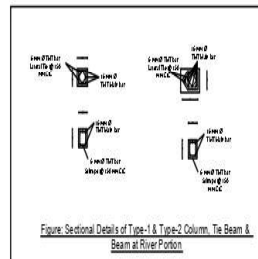
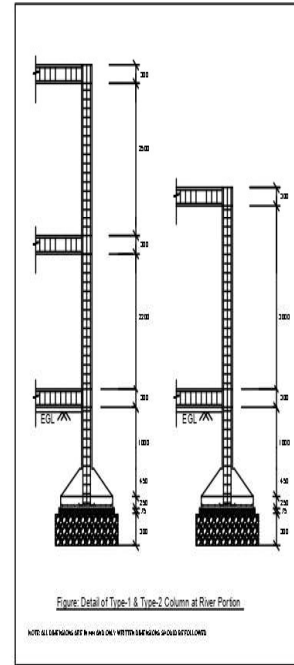
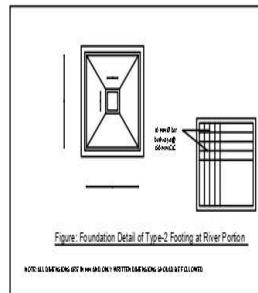
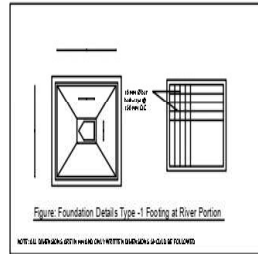
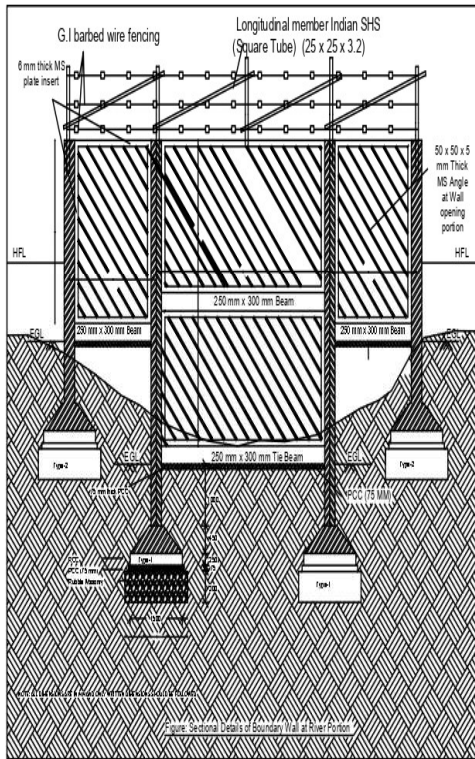

*Bayarsi*  
 Junior Manager  
 MSD-II, Namrup Civil Division  
 NTPS, APGCL, Namrup

*(Chandra et. Bora)*  
 Asstt. General Manager  
 Namrup Civil Division  
 NTPS, APGCL, Namrup

*(Signature)*  
 Assistant Manager  
 Namrup Civil Division  
 NTPS, APGCL, Namrup



